



HAL
open science

Summer comfort in attics: solar factor and operative temperature

J.B. Rieunier, B. Zeghondy, J. Gilles, Jean-Marie Alessandrini

► To cite this version:

J.B. Rieunier, B. Zeghondy, J. Gilles, Jean-Marie Alessandrini. Summer comfort in attics: solar factor and operative temperature. 4th IBPC, International building physics conference "Energy efficiency and new approaches", Jun 2009, Istanbul, Turkey. hal-04071996

HAL Id: hal-04071996

<https://cstb.hal.science/hal-04071996>

Submitted on 17 Apr 2023

HAL is a multi-disciplinary open access archive for the deposit and dissemination of scientific research documents, whether they are published or not. The documents may come from teaching and research institutions in France or abroad, or from public or private research centers.

L'archive ouverte pluridisciplinaire **HAL**, est destinée au dépôt et à la diffusion de documents scientifiques de niveau recherche, publiés ou non, émanant des établissements d'enseignement et de recherche français ou étrangers, des laboratoires publics ou privés.

Summer Comfort in attics: Solar factor and operative temperature

J.B. Rieunier & B. Zeghondy

Saint Gobain Isover R&D centre CRIR, France

J. Gilles

Saint Gobain recherche, France

J.M Alessandrini

Centre Scientifique et Technique du Bâtiment

ABSTRACT: Nowadays, a special attention is paid to avoid the global warming. However, the buildings energy consumption is still increasing because of the increasing demand of thermal comfort. This paper deals with summer thermal comfort.

“Human thermal comfort is the state of mind that expresses satisfaction with the surrounding environment” according to ASHRAE Standard 55. Thermal comfort depends on air velocities, radiant temperature and humidity... Most important for thermal comfort is the so called operative temperature T_{op} . This is the average of the air dry-bulb temperature and of the mean radiant temperature at the given place in a room. During a typical hot summer day, the maximum of T_{op} , called critical interior temperature T_{IC} , defines the summer comfort. T_{IC} is a function of many building parameters such as ventilation strategy, heat capacity C_j , U value and solar factor S or solar transmittance (according to EN ISO 13790, EN ISO 6946 and EN ISO 13789).

The aim of this paper is to deeply analyze the solar factor. In fact, S plays a major role in summer comfort; the radiative transmittance of the sun radiation impacts strongly the energy flux transmitted inside a building and increases its temperature, thus decreasing the thermal comfort.

In a first step, two methods to evaluate S are presented: In ventilated pitched roof, S cannot be calculated by simple rules and formula and must be measured or simulated because of ventilated air gap existence. A scale one climatic chamber test bench has been built at the CRIR research center to measure the solar factor of different insulation systems. Then, CFD simulations have been used as second method to calculate S taking into account natural convection, conduction and radiation heat transfer modes.

In a second step of this work, a comparison of different insulation systems is presented. The impact of air gap thickness, reflective barriers and extra openings has been studied on S values for different U values. The results showed a dependency between the thermal resistance of the insulation system and its solar factor S: the solar factor S is lower as the thermal resistance is higher.

In the last step, numerical simulations have been used to identify the impact of the solar factor on summer thermal comfort. The impact of the solar factor on the internal operative temperature and on the thermal comfort has been evaluated using a global simulation software. Results showed that a precise evaluation of this factor is necessary in order to calculate the occupants' feeling of their thermal.

1 INTRODUCTION

For long time, the special attention in European building research centres has been paid on winter comfort. Today many research centres are focused on the summer comfort to understand and improve the existing systems for a better comfort. Since 2003, the Saint Gobain CRIR research centre is studying the summer comfort to improve the system's summer performances. This paper deals with the main opaque surface parameters influencing the thermal comfort.

The main role of insulation is to avoid heat transfer through surfaces. This role is very important in win-

ter conditions, especially in high latitude (Europe, North America ...), where it helps to reduce the heat loss and the energy consumption. Others phenomena can be observed in summer conditions where this insulation reduce the solar gain but also reduce the energy evacuation from inside the building to the outside. Thus, we need to evaluate the impact of insulation on solar transmittance and heat evacuation during night period. Note that the choice of high insulation is not questionable in high latitude especially if we need to reduce the heating energy consumption by four and that during summer period the insulation reduce the solar transmittance. The main remaining points discussed in this paper are the in-

fluence of small variation of the high insulation on the solar factor and thermal comfort by mean of changing the air gaps configurations, the wind barrier emissivities and other details. Hence, in this paper, the thermal comfort is studied in attic houses because of the great interest that they present in term of comfort during very hot days, the large unprotected surface exposed to solar radiation and renovation work inside. As discussed before, the main difference between summer and winter comfort is the solar radiation intensity that plays a major role on the buoyancy and chimneys effect. Many works deal with the heat transfer through pitched roof and chimneys effect inside the existent air gaps. Some experimental work dealing with airflow rate inside air gap and their aspect ratio, inclination effect and analytical correlations fitted to experimental data can be found in Jyotirmay et. Al (2006), Chen et. al (2003), Krishnan et. al (2004) and Onur et. al (1997). Some numerical works evaluate the influence of these enumerated parameters on heat transfer coefficients inside the pitched roof as well as air gap thickness optimisation as in Lee (1999), Morrone et. al (1997), Thong et. al (2007) and Waewsak & Rarachitti (2006). Other works take into account the wind barrier emissivities as in Puangsombut et. al (2007), Khedari et. al (2002) and Biwole et. al (2008).

The main work presented in this paper shows the influence of an optimized roof's system on the thermal comfort inside attic houses. Instead of considering the heat transfer coefficient of the air gap or the airflow rate, we consider a new approach based directly on the heat transmittance factor (or solar factor) of the opaque roof system. Hence, in the first section the definition and the determination of the solar factor are presented. This determination takes into account the pitched roof technical characteristic influencing on the transmitted heat flux. Experimental and numerical tools are used to analyse and reduce the solar factor by the mean of a parametric study allowing us to propose systems with very low solar factor and high thermal resistance. The last section shows the impact of the proposed solution on the internal temperature of the attic house and on human comfort.

2 SOLAR FACTOR DETERMINATION IN PITCHED ROOF

2.1 Definition

As mentioned above, the summer comfort is strongly influenced by the solar heat flux. To characterize the transmitted heat flux into the building, the solar factor S is defined as follows:

$$S = \frac{Q_i}{I_{SR}} \quad (1)$$

where Q_i is the transmitted heat flux [W/m^2] into the inside surface of the building's system and I_{SR} is the incident solar radiative flux [W/m^2].

For simple configurations where no ventilated air gap is present, the heat transfer modes can be limited to conduction (inside the solid surfaces), radiation and convection at the external surfaces. Thus, by writing the energy conservation equations the solar factor S can be simply determined by:

$$S = \frac{\alpha U}{h} \quad (2)$$

where α is the absorptivity of the external surface, U is the heat transfer coefficient of the solid system (no ventilated air gaps) [W/m^2K] and h is the external convective heat transfer coefficient [W/m^2K]. When the system presents ventilated air gaps, the chimney effect should be added to the energy conservation equations. This task could be difficult especially that a simple comparison of the reviewed correlations showed that they don't fit with experimental data in most cases. The reason is that each correlation is fitted for a given system (inclination, thickness, surface emissivities ...).

2.2 Experimental test bench: The CRIR Climatic Chamber (3C)

In order to determine this solar factor we used two methods. The first one is experimental by the mean of the CRIR Climatic Chamber (3C) experimental test bench. The second method is based on CFD simulations.

The 3C experimental test bench is designed to exclusively measure the solar factor (Fig. 1). The 3C is a large scale test bench with 45° inclination pitched roof and large dimensions $4*4m^2$ each side. It is equipped with a large number of sensors; 32 thermocouples at each surface layer (gypsum board, internal and external surface of the insulation and the outside tiles surface); 8 heat flow transducers at the internal surface of the gypsum board to measure the transmitted heat flux (Q_i); a pyranometer to measure the incident solar heat flux (I_{SR}) over the tiles surface. The solar radiative source is ensured by the mean of 42 projectors of 1kW power each (see Fig. 1) operating at the solar temperature of 6000K, such a way that the incident flux I_{SR} can varies from 0 to $1000 W/m^2$ by adjusting the distance between the projectors and the tiles. The large number of sensors enabled us to validate the simulation method. At each I_{SR} we measure Q_i at a steady state regime and where internal and external side of the roof are at the same air temperature (inside temperature = outside temperature). The reason of the last hypothesis is to be sure that the measured transmitted flux is not related to temperature difference of air.



Figure 1. The 3C apparatus; 42 projectors to ensure the solar source radiation; a 45° angle pitched roof can be easily mounted with different systems inside.

In order to determine the solar factor S , we consider a linear correlation between the transmitted flux Q_i and the incident one I_{SR} . By fitting a straight line between the incident and transmitted heat flux data, we obtain the solar factor S as the slope of the straight line (see Fig.2, data experimentally obtained on geometry described in Fig. 3).).

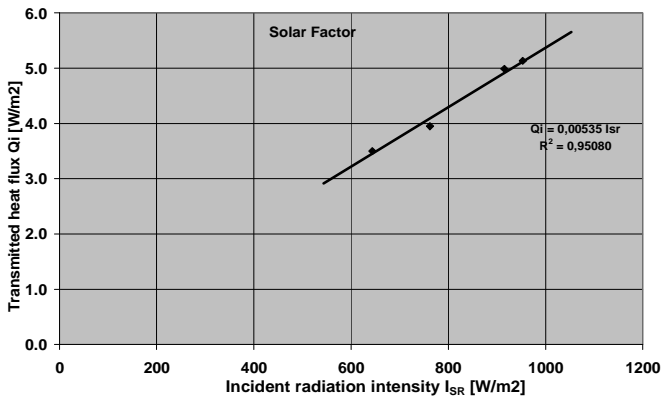

Figure 2. The interior heat flux Q_i function of I_{SR}

The steady state is obtained when all the measured temperature deviation is less than 0.5°C and the heat flow deviation is less than 7%. With these conditions, the dynamic determination of the solar factor showed that the relative error is less than 0.4% according to the standard ISO 9869:1994.

2.3 Numerical simulations

Another method used to determine the solar factor S is simulations. A 3D CFD fluent® model is used to determine the heat and mass transfer of the pitched roof. The figure 3 presents an overview of the complete system and the figure 4 gives the details of the different components. This model considers radiation between internal, external and intermediate (air gap) solid surfaces. The conduction transfer mode is considered into the solid materials and insulation (an equivalent conductivity is used for porous insulation taking into account all heat transfer phenomena including radiation). The buoyancy effect inside the air gap is also considered (See Figure 3 detail 10).

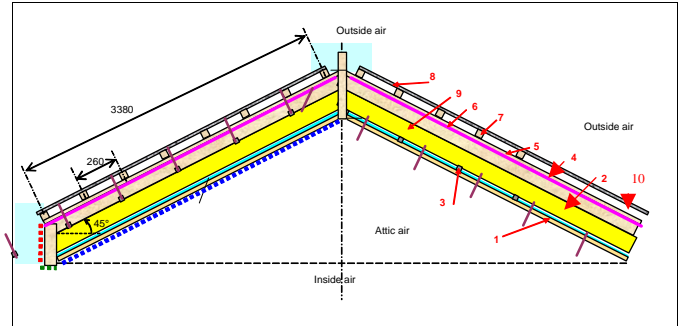

Figure 3.1 Pitched roof configuration

The simulations are done for a steady state, the boundary conditions are as follows: The outdoor air temperature equals the indoor air temperature, a given external heat transfer coefficient at the tiles level and finally a constant heat transfer coefficient at the internal gypsum surface. For each simulation we considered an incident solar heat flux between 0 and 1000 W/m². A comparison with the experimental data enabled us to verify the right heat transfer coefficients at the internal and external side (8 and 13 W/m²K) fixed by the RT2005 regulation. The comparison between the experimental and numerical data shows that the relative error over the transmitted heat flux Q_i is less than 10% and the relative error over the surface temperatures is less than 3°C (for the tiles).

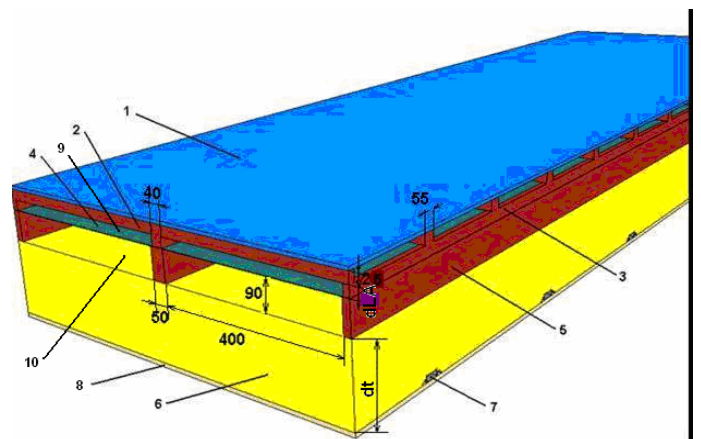

Figure 4: 1 - Tiles ; 2 – battens ; 3 - Laths ; 4 – high vapor permeability wind barrier; 5 – rafters; 6 – Glass wool; 7 – steel studs ; 8 – Gypsum board ; 9 – ventilated air gap; 10 – unventilated air gap.

The numerical results showed a good agreement with experiments. Note that for France standards, the default solar factor S value in summer is fixed at 0.02 if it's not correctly determined. To give an idea about the measured data, the measured system of thermal resistance of 5 m²K/W as showed in Figure 4 has experimentally a Solar factor $S = 0.0059$ against a numerical S of 0.0063, (calculated by imposing experimental I_{SR} from 650 to 970W/m² and air temperature to compare transmitted heat flux Q_i

and solar factor S), which means a relative error on S less than 10% (See Fig. 5). The low solar factor is directly related to the thermal resistance (see next section).

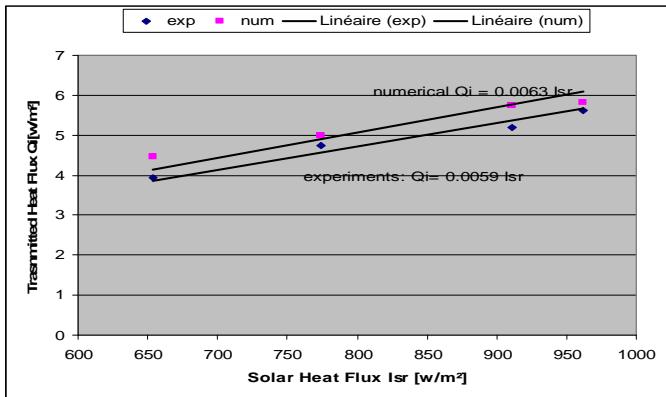

Figure 5: experimental and numerical comparison of solar factor; Q_i function of the incident heat flux radiation; solid line: experiments; dashed line: simulations.

3 PARAMETRIC STUDY

In order to improve the pitched roof summer performances, a parametric study is done. The goal of this study is to identify by order of importance the influence of each parameter on the solar factor. The considered main parameters are the system's thermal resistance, the air gap thickness, the wind barrier emissivity and the extra openings.

3.1.1 Effect of the thermal resistance

A good improvement of the solar factor S is viewed when the thermal resistance is increased from 1 to $5 \text{ m}^2\text{K/W}$, 70% reduction of S is established as shown in Figures 6 and 7. An increase of the thermal resistance above $5 \text{ m}^2\text{K/W}$ will have a weak effect on the reduction of the solar factor.

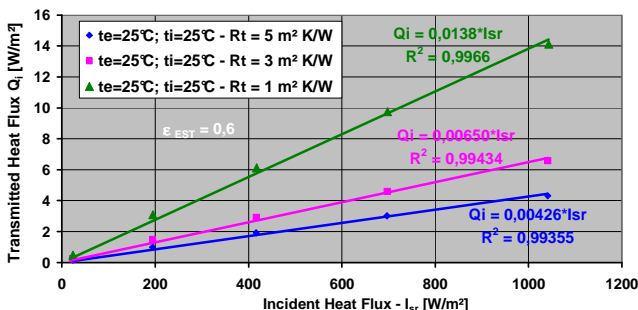

Figure 6. Q_i (solar factor S) function of the thermal resistance.

3.1.2 Effect of the ventilated air gap thickness

The reduction of the solar factor can be viewed in Figure 7. An increase of the air gap from 20 to 100mm can reduce the solar factor about 20%. The reason of this reduction is that the air flow will increase because the pressure loss is decreasing when

the gap is larger; hence the air will extract more energy (from the tiles and the wind barrier) and less energy will cross the roof's components. Note that most of the gain of the solar factor reduction is obtained when the air gap thickness varies from 20 to 50mm (16 to 18% according to the thermal resistance of the system). A thicker air gap is not necessarily well viewed especially that there is no significant reduction of S (less than 2% between 50 and 100mm as shown in Figure 7).

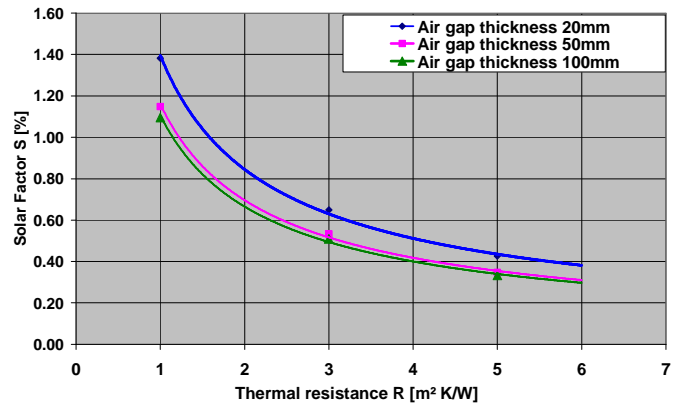

Figure 7: S function of thermal resistance for various ventilated air gap thickness with a wind barrier emissivity $\epsilon=0.6$.

The existence of the optimized air gap thickness is validated also in Thong et. Al (2007).

3.1.3 Effect of the wind barrier emissivity

The simulations are done for a ventilated air gap thickness of 50mm and a thermal resistance of $5 \text{ m}^2\text{K/W}$. The ordinary high vapor permeability wind barriers have usually an emissivity ϵ of 0.6 to 0.8 (lower and upper surfaces).

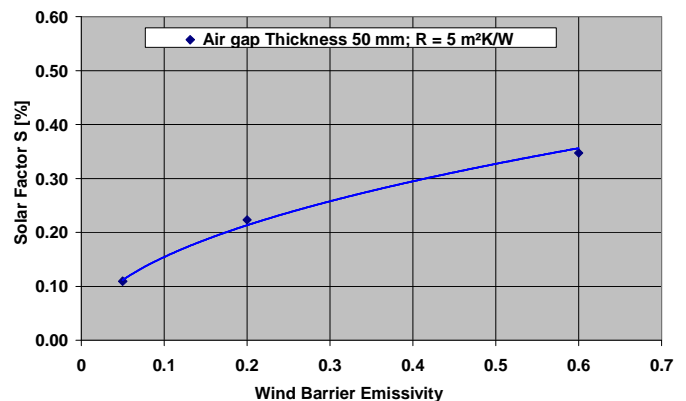

Figure 8: Solar factor function of the wind barrier emissivity ϵ ; thermal resistance $5 \text{ m}^2\text{K/W}$; ventilated air gap thickness 50mm.

Some improved wind barriers have an emissivity of 0.2. In these simulations ϵ was varied between 0.05 and 0.6, knowing that, currently, the permanent value of 0.05 doesn't exist because of ageing but can be represented by a highly performed aluminized

film. Results are shown in Figure 8, the reduction of the solar factor when the emissivity varies from 0.6 to 0.05 is about 30%. The system shown in Figure 4 was also measured by replacing the normal wind barrier ($\epsilon=0.8$) by a reflective one ($\epsilon=0.2$). Experiments showed a reduction of the solar factor of 20%; the measured solar factor is 0.0045 against 0.0056 with the normal wind barrier which represent the same order of reduction as shown in Figure 8.

3.1.4 Effect of the extra openings in the roof

The aim of this modification is to create an extra opening in the middle of the roof to help the energy evacuation by renewing the fresh air in the ventilated air gap (see Fig. 9).

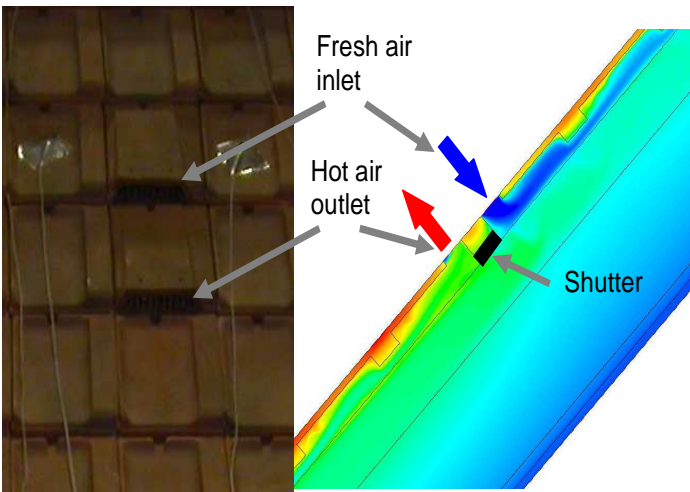

Figure 9: installation of extra openings.

Hence, the ventilated air gap is divided into two separate air gaps; the first one is an exhaust of the air that enters the air gap from the eaves level (cold air) and leave at this first opening (hot air); the second opening is an entry of cold air that will exhaust the air gap at the ridge level once it's hot (see Fig. 9).

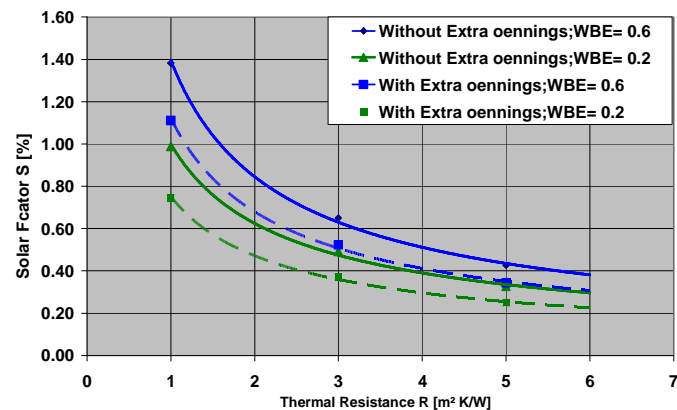

Figure 10: solar factor reduction with or without extra openings; Air gap Thickness =20mm; WBE = Wind barrier Emissivity.

The simulation are considered for various thermal resistance with an air gap of 20mm thickness and two wind barriers emissivities ($\epsilon=0.2$ and 0.6). Re-

sults show that the solar factor reduction is between 14 to 19% depending on the thermal resistance, the highest reduction is observed for high thermal resistance. One should note that these reductions are of the same order whether the emissivity is 0.2 or 0.6. (Fig.10).

4 IMPACT OF SOLAR FACTOR ON ATTIC HOUSE THERMAL COMFORT

In this section we show the impact of the roof solar factor on the thermal comfort during summer period in an attic. In order to quantify the effect of a very low solar factor, we used the operative temperature (T_{op}) inside the attic as observed target. The T_{op} is the average of the air-dry bulb temperature and of the mean radiant temperature at the given place in a room. The aim is to simulate the operative temperature of a building during a hot day. Thus, to understand the impact of solar irradiation, we decided to do a parametric study over the pitched roof components. The temperature is calculated with the french regulation model known as "méthode Th-CE 2005" [méthode Th-CE]. However, the description of the thermal comfort given by this temperature is limited. It can not show, for example, the dispersion of occupant's perception of the inside climate. Thus, we also used the EN ISO 7730 standard [EN ISO 7730] to estimate the thermal comfort of the inside climate.

4.1.1 Description of the attic

The attic of a typical two level french house is considered in the Trappes's French area. This attic has a living surface of 61m² (see Fig.11).

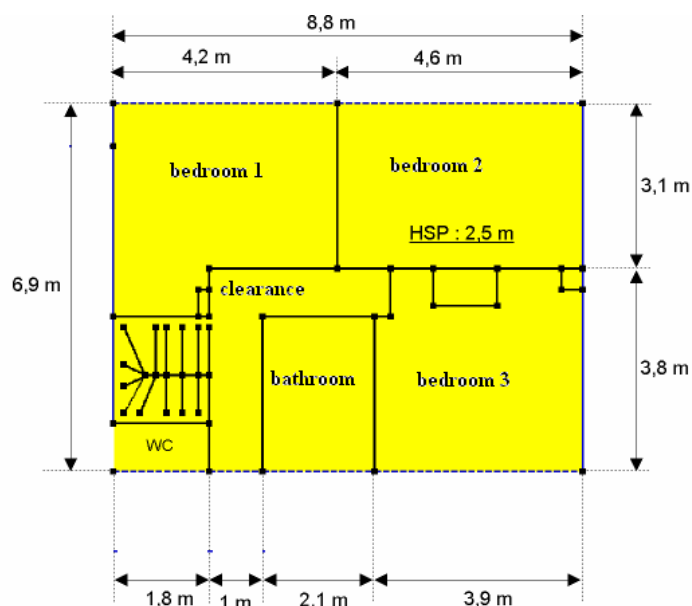

Figure 11: attic main geometrical characteristics

Main physical characteristics of the dwelling are given in table 1.

Table 1. physical characteristics

climate	A hot day in summer in Paris neighbourhood
Inertia	Light
Walls surface	56.52 m ²
Roof surface	58.24 m ²
Roof windows surface	2.76 m ²
Uwindows	2.1W/m ² /K
Windows solar factor	0.1
Uwalls	0.4W/m ² /K
Walls solar factor	0.02
Occupant's heat gains	5 W/m ² all day long
Open windows	Fully open from 0 to 9h am and from 8 to 12h pm

The parquet roof and inside insulation lead to a light inertia [Th-I]. Clear solar protection, such as travelling shutters, leads to a 0.1 solar factor under summer conditions [Th-S]. Occupant heat gains and open windows schedules are conventional as in the French regulation.

The impact of the roof solar factor is studied using two kinds of roof:

- A reference one with a 0.2 W/m²/K U value and a 0.02 solar factor, such as 20 cm insulation pitched roof made of two cross layers.
- An improved one with a 0.1 low emissivity wind barrier, which leads to a 0.2 W/m²/K U value and a 0.003 solar factor.

4.1.2 Description of the simplified model

The inside operative temperature is calculated with the French regulation thermal model also used for summer calculation standard NF EN ISO 13792. The calculation method is based on the simplifications of the heat transfer between the internal and external environment reported in figure 12.

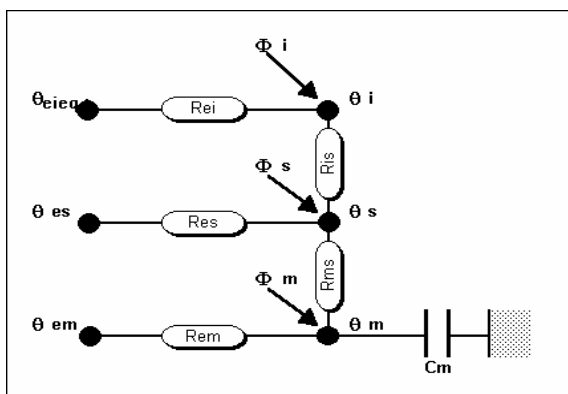

Figure 12: Capacity and resistance network

This simplified hourly calculation method makes a distinction between the internal air (θ_i), mean radiant temperature for opaque walls (θ_m) and (θ_s) temperature for the indoor environment. This enables to use it for thermal comfort checks and increases the accuracy for taking into account the radiative (Φ_s & Φ_m) and convective (Φ_i) part of solar, lighting, and internal gains. Air temperature, long wave radiation

and solar radiation are integrated in outside equivalent temperature of walls (θ_{em}) and windows (θ_{es}).

4.2 Impact of solar factor on operative temperature

In this section, we show the effect of the roof solar factor on the operative temperature during a hot summer day (figure 13). Internal operative temperatures obtained in an attic, with a 0.02 roof solar factor (projet 2) and a 0.003 one (projet 1), are compared.

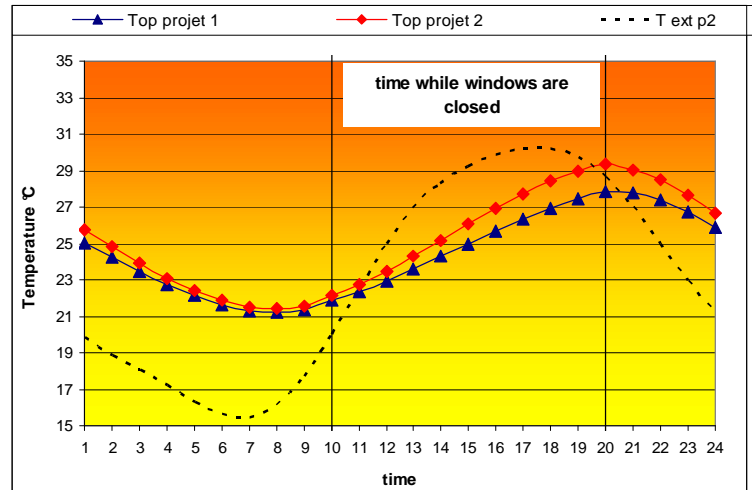

Figure 13: inside operative temperature in an attic with two different roof solar factors.

The highest temperature is observed at 8 PM just before windows are open. Thus the outside decreasing temperature can cool the attic.

With a 0.003 roof solar factor the higher Top is almost two degrees below the higher Top obtained with a reference solar factor for the roof.

The difference is not huge but it occurs around 28°C, temperature usually considered as limit for thermal comfort.

Another way to explore the impact, is to look at the thermal comfort inhabitants satisfaction level. Thus we use thermal comfort standard EN ISO 7730.

4.3 Impact of solar factor on occupant perception

The EN ISO 7730 standard proposes to estimate the dissatisfied people percentage of an inside thermal environment according to five parameters:

- Clothes,
- Occupants' activity,
- Operative temperature,
- Air velocity,
- Relative humidity.

Thus, at each time step the operative temperature is used to estimate the dissatisfied people percentage assuming the following values of the input variables:

- thermal resistance of the clothing = 0.5 clo
- metabolic rate = 1.4 met
- air velocity < 0.1 m/s
- relative humidity = 50%

Figure 14, dotted curves give the evolution of this percentage for the two roofs presented before:

- The red one for 0.02 roof solar factor (projct 2)
 - The blue one for 0.003 roof solar factor (projct 1)
- Black line is the operative temperature for which the percentage of dissatisfied is the lowest (5%).

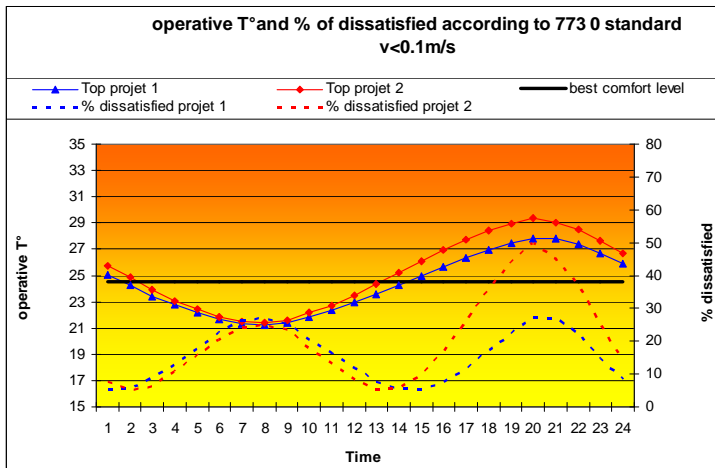

Figure 14: dissatisfied people percentage in an attic with two different roof solar factors.

At the hottest time in the day around 8 pm, with a 0.02 roof solar factor the dissatisfied people percentage is almost 50% whereas it decreases below 30% for the other case. Thus with an improved solar factor the probability that inhabitants feel uncomfortable is almost twice lower. This means that it is possible to stay in the thermal comfort area.

The air velocity is a way to improved heat transfers between the body and the environment. Under hot temperature it can lead to a better feeling of the thermal environment. On figure 15, the same comparison as before is lead with a 0.5 m/s air velocity, which can be obtain with a fan.

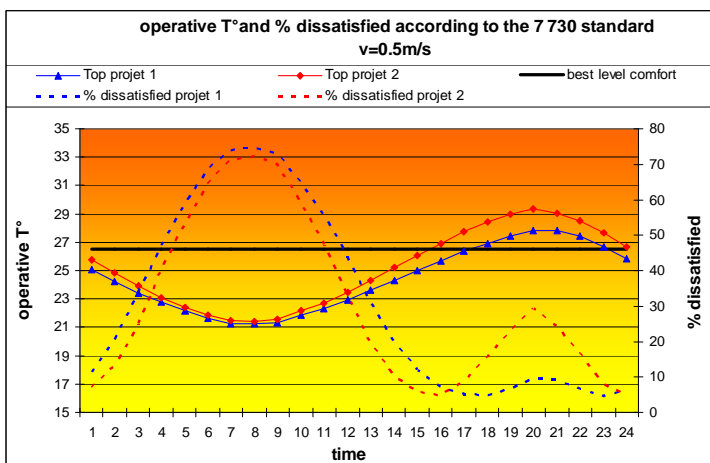

Figure 15: dissatisfied people percentage in an attic with two different roof solar factors with a 0.5 air velocity.

During night and early morning we can suppose that huge majority of occupants stop the fan. Thus the percentage of dissatisfied is not realistic at these times.

During hottest time in day, between 8 and 9 pm, coupling a high air velocity and an improved solar factor leads to optimal comfort level. The probability to have an occupant dissatisfied of its thermal comfort is below 0.1.

5 CONCLUSION

In this paper, we presented a brief summary of the research work concerning the summer comfort done by the CRIR research centre and its collaborators.

One of the key parameters to improve the summer comfort is the so called solar factor S.

Two direct methods to evaluate the solar factor or solar transmittance are presented: an experimental test bench, 3C apparatus, is specially designed to measure the solar factor and a simulation code is also validated by comparison with the experimental data issued from experiments.

The parametric study and the measurements showed the main parameters influencing the solar factor by order of importance: i) the first interesting parameter is the thermal resistance, ii) the air gaps thickness, iii) the wind barrier emissivity iv) and the last important parameter is the extra openings.

In order to show the interest of reducing the solar factor, the operative temperature of an attic house during summer period is simulated. The percentage of dissatisfied has been calculated as well. Results show that a precise evaluation of this factor is necessary in order to calculate the occupants' feeling of their thermal environment. More precisely a roof solar factor variation from 2% to 0.3% can divide by two the dissatisfied people percentage their thermal comfort under specific hypothesis. The model gives a good idea of the impact of solar factor. However to improved effective value two points need more studies:

- The solar factor evolution with solar radiation incidence angle.
- The roof slope.

REFERENCES

- Jyotirmay, M., Sanjay, M. and Sanjay, A. 2006. Experimental investigation on four different types of solar Chimneys. *national conference on advances in energy research IIT-Bombay*
- Chen, Z.D., Bandopadhyay, P., Halldorsson, J., Byrjalsen, C., Heiselberg, P. and Li, Y. 2003. An experimental investiga-

- tion of a solar chimney model with uniform wall heat flux. *Building and Environment* 38: 893-906
- Krishnan, A., Balaji, C. and Venkateshan, S.P. 2004. An experimental correlation for combined convection and radiation between parallel vertical plates. *Journal of Heat Transfer* 126: 849:851
- Onur, N., Sivirioglu, M. and Aktas, M.K 1997. An experimental study on the natural convection heat transfer between inclined plates (Lower plate isothermally heated and the upper plate thermally insulated as well as unheated). *Heat and Mass Transfer* 32: 471-476
- Khedari, J., Yimsamerjit, P. and Hirunlabh, J. 2002. Experimental investigation of free convection in roof solar collector. *Building and Environment* 37: 455-459
- Lee, K.T. 1999. Natural convection heat and mass transfer in partially heated vertical parallel plates. *International Journal of heat and Mass Transfer* 42: 4417-4425.
- Puangsoambut, W., Hirunlabh, J., Khedari, J., Zeghmati, B. and Win, M.M. 2007. Enhancement of natural ventilation rate and attic heat gain reduction of roof solar collector using radiant barrier. *Building and Environement* 42:2218:2226
- Miller, W., Keyhani, M., Stovall, T. and Yougquist, A. 2007. Natural convection heat transfer in roofs with above-sheathing ventilation. *Thermal Performance of the Exterior envelopes of Buildings X, Proceedings of ASHRAE THERM X, Clearwater, FL*
- Biwole, P.H., Woloszyn, M. and Pmpeo, C. 2008. Heat transfers in a double-skin roof ventilated by natural convection in summer time. *Energy and Buildings* 40: 1487-1497
- Morrone, B., Campo, A. and Manca, O. 1997. Optimum plate separation in vertical parallel plate channels for natural convective flows: incorporation of large spaces at the channel extremes. *International Journal of Heat and Mass Transfer* 40:993-1000
- Waewsak, J. and Sarachitti, R. 2006. An investigation of natural ventilated roofs by means of computational fluid dynamics. *Thammasat Int. J. Sc. Tech.* (1) 11: 21-32
- Thong, T.B., Quaan, L.M. and Seng O.K. 2007. Simulations of flow in a solar roof collector driven by natural convection. *16th Australasian Fluid Mechanics Conference, Crown Plaza, Gold Coast, Australia*
- ISO 9869:1994. Isolation thermique. Elements de construction; Mesurage In situ de la résistance thermique et du coefficient de transmission thermique.
- ISO 7730:2005. Ergonomics of the thermal environment -- Analytical determination and interpretation of thermal comfort using calculation of the PMV and PPD indices and local thermal comfort criteria
- ISO 13790:2004. Thermal performance of buildings -- calculation of energy use for space heating.
- ISO 6946:2007. Building components and building elements -- Thermal resistance and thermal transmittance --Calculation method.
- ISO 13789: 2007: Thermal performance of buildings -- transmission and ventilation heat transfer coefficients -- Calculation method.
- ISO 13792: 2005: Thermal performance of buildings -- calculation of internal temperatures of a room in summer without mechanical cooling -- simplified methods.
- Réglementation thermique 2005, Guide réglementaire, ouvrage de base, CSTB février 2007
- Th-I 2007, règle d'application Th-Bat, Th-I, guide réglementaire, ouvrage de base, CSTB février 2007
- Th-S, règle d'application Th-Bat, Th-S, guide réglementaire, ouvrage de base, CSTB février 2007