



HAL
open science

Modelization of the aeraulic in a wood-burning appliance

Jean-Pierre Leclerc, Roda Bounaceur, Olivier Herbinet, Frédérique Battin
Leclerc, Céline Le Dreff, Sylvain Aguinaga, Mélanie Nicolas

► To cite this version:

Jean-Pierre Leclerc, Roda Bounaceur, Olivier Herbinet, Frédérique Battin Leclerc, Céline Le Dreff, et al.. Modelization of the aeraulic in a wood-burning appliance. Tracer8, 8th international Conference on Tracers and Tracing Methods, Feb 2019, Đà Nẵng, Vietnam. hal-02390721

HAL Id: hal-02390721

<https://cstb.hal.science/hal-02390721>

Submitted on 3 Dec 2019

HAL is a multi-disciplinary open access archive for the deposit and dissemination of scientific research documents, whether they are published or not. The documents may come from teaching and research institutions in France or abroad, or from public or private research centers.

L'archive ouverte pluridisciplinaire **HAL**, est destinée au dépôt et à la diffusion de documents scientifiques de niveau recherche, publiés ou non, émanant des établissements d'enseignement et de recherche français ou étrangers, des laboratoires publics ou privés.

Modelization of the aeraulic in a wood-burning appliance

Jean-Pierre LECLERC¹, Roda BOUNACEUR¹, Olivier HERBINET¹, Frédérique BATTIN LECLERC¹, Céline LE DREFF², Sylvain AGUINAGA² and Melanie NICOLAS²

¹Laboratoire Réaction et Génie des Procédés, LRGP, France

²CSTB, France

Jean-pierre.leclerc@univ-lorraine.fr

ABSTRACT

The objective of the project research project is to take into account the impact of aeraulics in a wood burning appliance, in order to better manage the distribution of gas flows, in view of optimizing combustion and thus reducing pollutant emissions at the source. To this end, this whole project proposes two complementary modeling approaches, which will be coupled with experimental measurements of Residence Time Distribution (RTD) and pollutant emissions.

The work presented here deals with the modeling of the flow by Computational Fluid Dynamics, the experimental measurements of RTD and their analysis, as well as the modeling of the aeraulic within the heating appliance using the DTS-Pro software [1].

These early CFD modeling works, as well as the overall flow model proposed using the DTS Pro software based on experimentally measured Residence Time Distributions (RTD), are promising. They made it possible to set up a methodology adapted to the study of the aeraulic in a wood-burning appliance according to two distinct approaches and they provide results that prove to be coherent and complementary.

In this paper, we do not present results coming from CFD modelling.

DESCRIPTION OF THE WOOD-BURNING APPLIANCE 1

Experimental Resident Time distribution have been studied by introducing tracer in different position of a wood-burning appliance. We have choose Krypton (m/z 84) as a tracer and the analytical system OmniStar with a mass range of 1–200 amu from PFEIFFER to analyze the gas flow in continue.

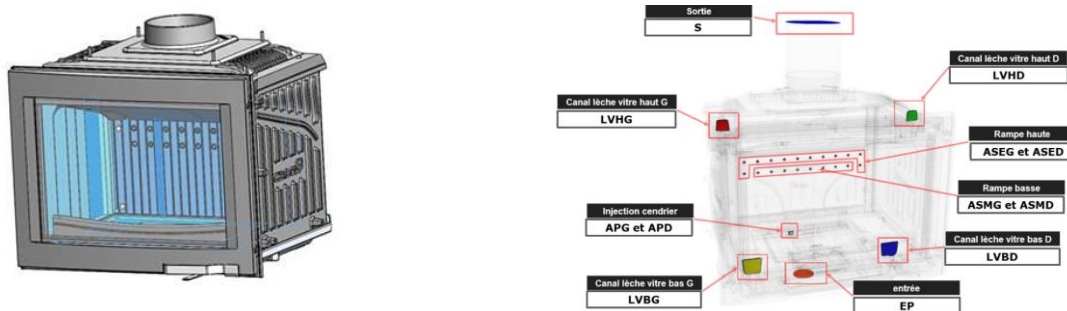

Depends on the position of the injection we obtained different kind of signal.

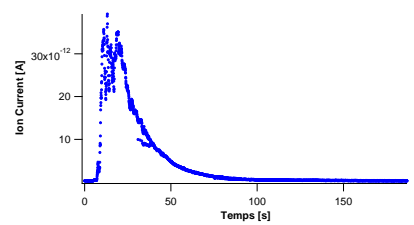
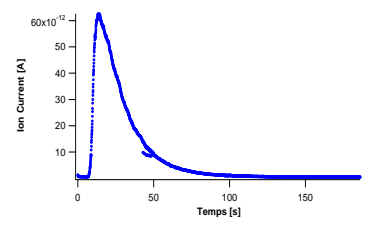
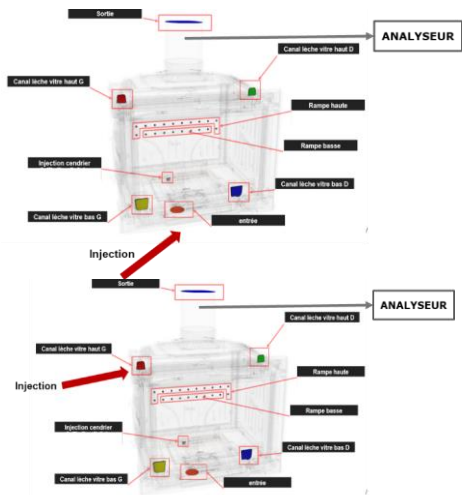

Using the software DTS-Pro we propose an aerualic model for the wood-burning appliance. Whatever the position on the injection of tracer, the experimental and simulated result are in good agreement. This model allow us to determine the resident time distribution inside the oven, roughly it take 11 s from the entrance to the outlet.

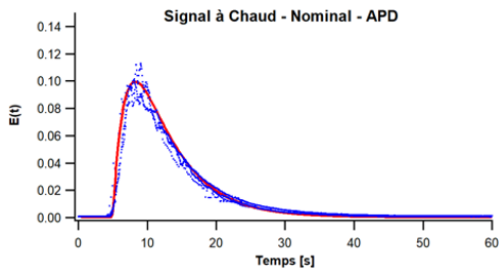
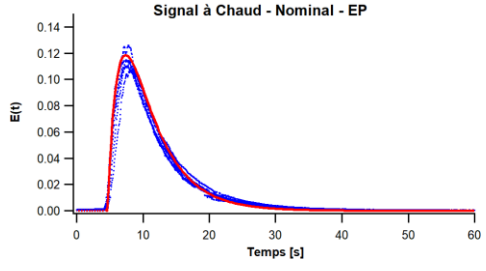
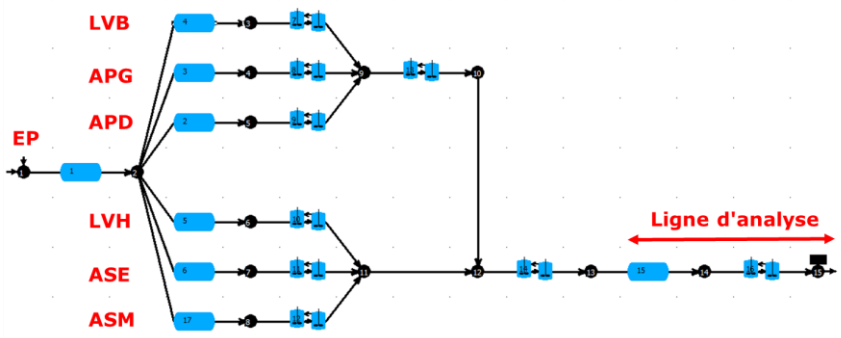

KEYWORDS:

aerualic, wood-burning appliance, combustion

REFERENCES

[1] LECLERC J. P., ANTOINE B., Software “DTSPRO V4.2”, PROGEPI LSGC – CNRS – ENSIC, Nancy, 2000



Mass spectrometer connected in line to a wood stove

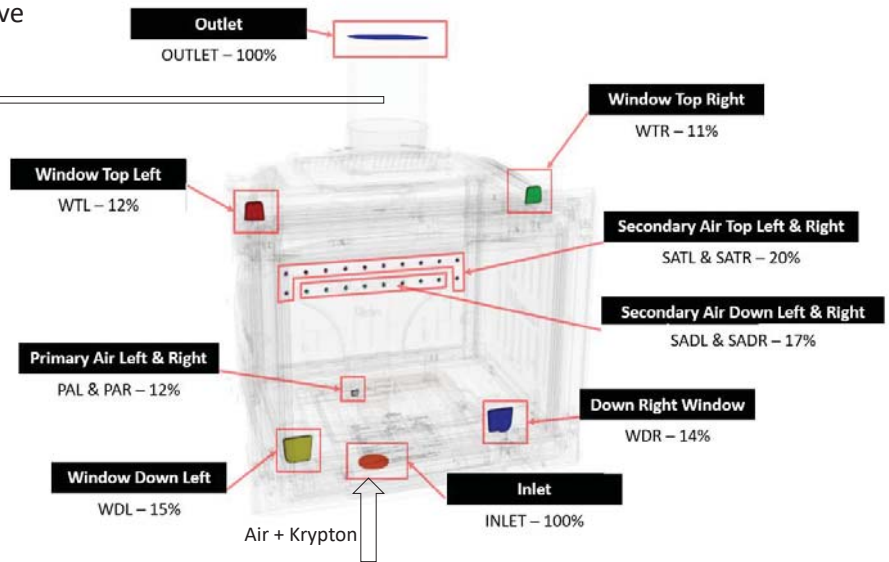

Objective

- The objective of the project research is to take into account the impact of aerualics in a wood burning appliance, in order to better manage the distribution of gas flows, in view of optimizing combustion and thus reducing pollutant emissions at the source.
- The work presented here deals with the modeling of the flow by experimental measurements of RTD and their analysis, as well as the modeling of the aerualic within the heating appliance using the DTS-Pro software [1].

CFD calculation

Presence of
3 zones of recirculation

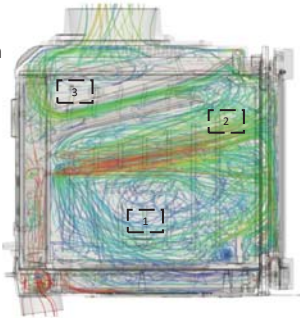

Experimental approach

- Krypton (m/z 84) was injected with air at different position of the wood-burning appliance
- The pulse was measured in continue through a mass spectrometer from Pfeiffer (OMNISTAR - detection limit=500ppb)
- **Volume of the wood stove: $V = 70.6$ l**
- Two different flow rates have been studied: $Q_1 = 26 \text{ m}^3 \cdot \text{h}^{-1}$ and $Q_2 = 20 \text{ m}^3 \cdot \text{h}^{-1}$
- Free Residence time: $\tau_1 = \frac{V}{Q_1} \sim 10 \text{ s}$ and $\tau_2 = \frac{V}{Q_2} \sim 13 \text{ s}$
- Flow rates at different positions have been calculated by CFD calculation
- Two different conditions:
 1. Hot condition – with wood burning
 2. Cold condition – without wood burning

Results

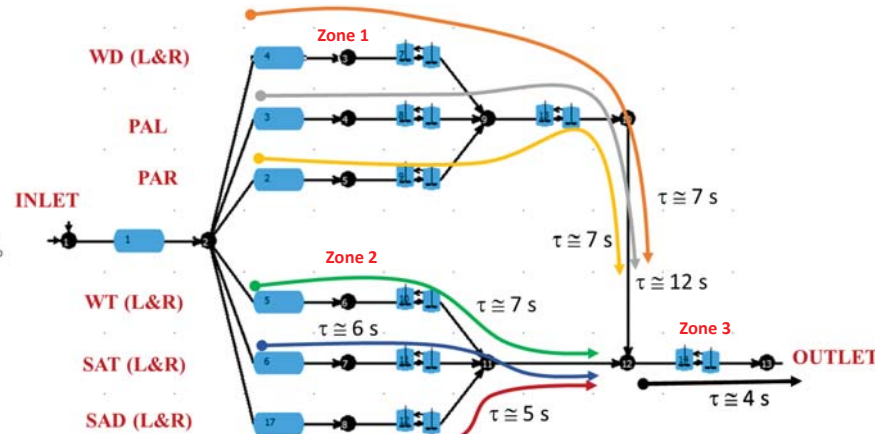

RTD Signals

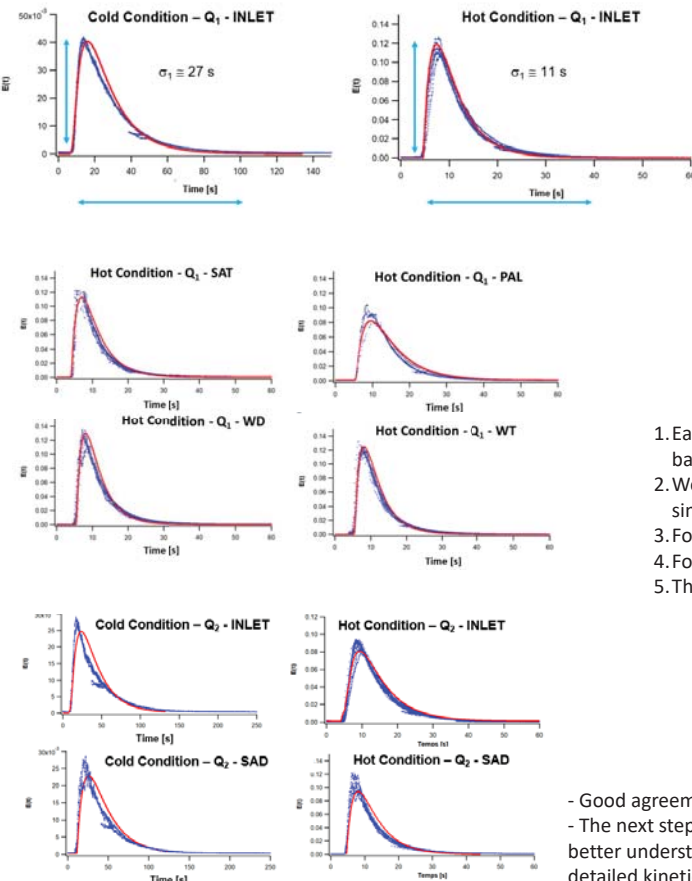

Methodology

1. Each branches (WD, PAL, etc ...) have been modeled with a plug-flow followed by a mixer with back-mixing. For our convenience we have fixed $J=2$ and $\alpha=0.27$
2. We have used the compartment model to modeled the whole system by varying by simulation the different positions of injection
3. For Cold or Hot Condition, the architecture of the compartment model is conserved
4. For Cold or Hot Condition, we fixe Q_1 and we optimize the different volumes of each modules
5. These volumes are conserved for the simulation with Q_2

	Hot Condition		Cold Condition	
	Q_1	Q_2	Q_1	Q_2
Average residence time from the inlet (s)	12	17	27	37
Equivalent total volume (l)	≈ 90		≈ 200	
Volume Zone 1	≈ 29			
Volume Zone 2	≈ 35			
Volume Zone 3	≈ 26			

- Good agreement between experiments and simulations whatever the condition and the flow rate
- The next step is to couple the RTD model with a full detailed kinetic model for the combustion of wood in order to better understand the formation of pollutant. The kinetic model has already been published: "Development of a detailed kinetic model for the combustion of biomass", Dhahak and al., Fuel, 242, 756-774, 2019.